



Features

- ◆ The common mode filter is mainly used to reduce radiation and high frequency common mode noise.
- ◆ Reduce asymmetric interference on CAN, power and other interfaces.
- ◆ Small package large current to meet a variety of circuits
- ◆ Low leakage, no effect on differential mode current
- ◆ Packaging quantity:500pcs

Application

- ◆ Portable devices
- ◆ Digital cameras
- ◆ Player
- ◆ Smart home
- ◆ Robot

Part Numbering

CMF	4532	WA	121	M	Q	T
A	B	C	D	E	F	G

A:ASIM common mode filter

B:Dimension

C:Wire wound

D:Common Mode Impedance (at 100MHz), 121=120 Ω

E:Tolerance M±25%

F:Internal series

G:Tape

Specification

Part number	Common mode impedance(Ω) @100MHz	Rated Current (A)	DC Resistance (Ω) max
CMF4532WA121MQT	120±25%	3.0	0.07
	Rated volt max(Vdc)	Withstand volt (Vdc)	IR (Ω) min
	50.0	50.0	10M

Performance Curves

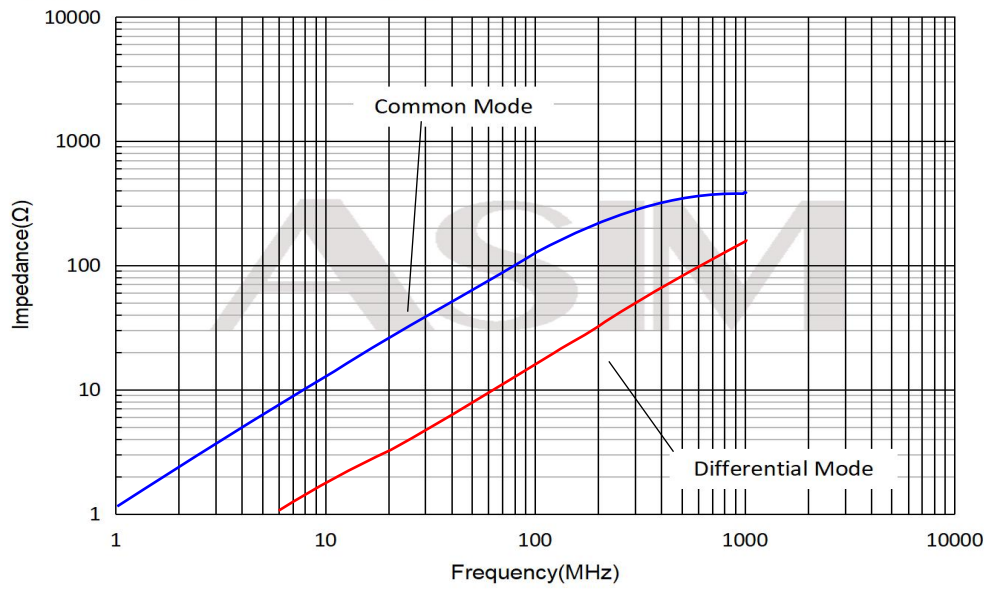

Dimension (mm)

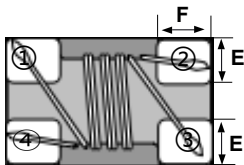
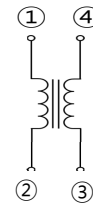
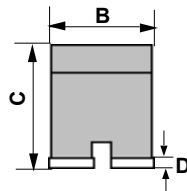
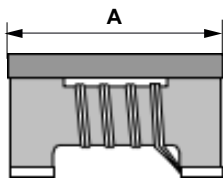

PIN NUMBER	DESCRIPTION
① ~ ②	DATA LINE
④ ~ ③	DATA LINE

Series	A(mm)	B(mm)	C(mm)	D (mm)	E (mm)	F(mm)
4532	4.5±0.2	3.2±0.2	2.8±0.2	0.2±0.1	1.2Typ.	1.0Typ.

Recommended Land Pattern (mm)

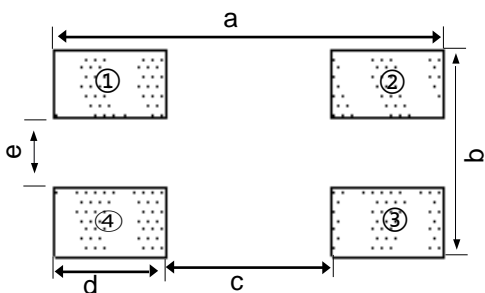

Symbol	a	b	c	d	e
Dimension	5.1	3.39	2.4	1.35	0.75

Recommended Reflow Profile

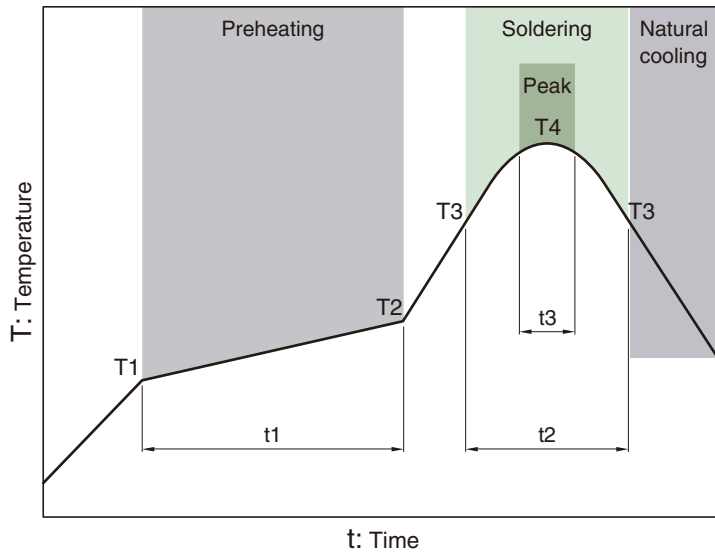

Preheating			Soldering		Peak	
Temp.	Temp.	Time	Temp.	Time	Temp.	Time
T1	T2	t1	T3	t2	T4	t3
150°C	180°C	60 to 120s	230°C	25 to 35s	250°C	5s

Reel Dimension & Tape Dimension (mm)

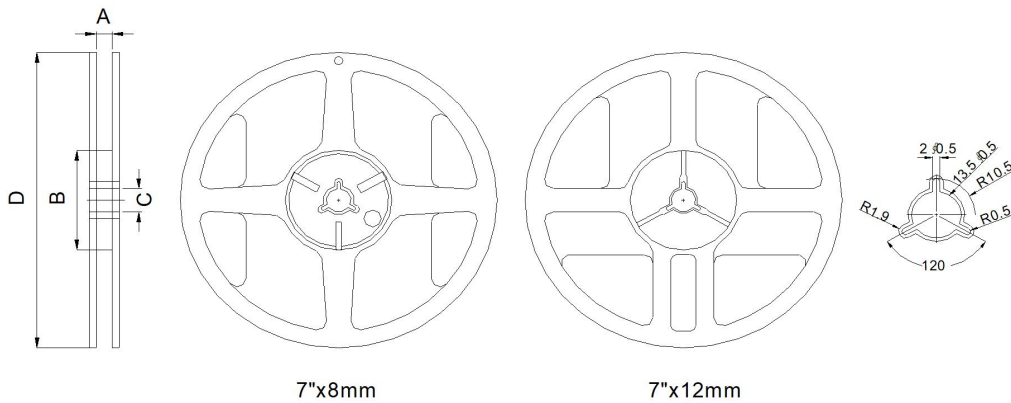

Type	A(mm)	B(mm)	C(mm)	D(mm)
7"x8mm	9.0±0.5	60±2	13.5±0.5	178±2

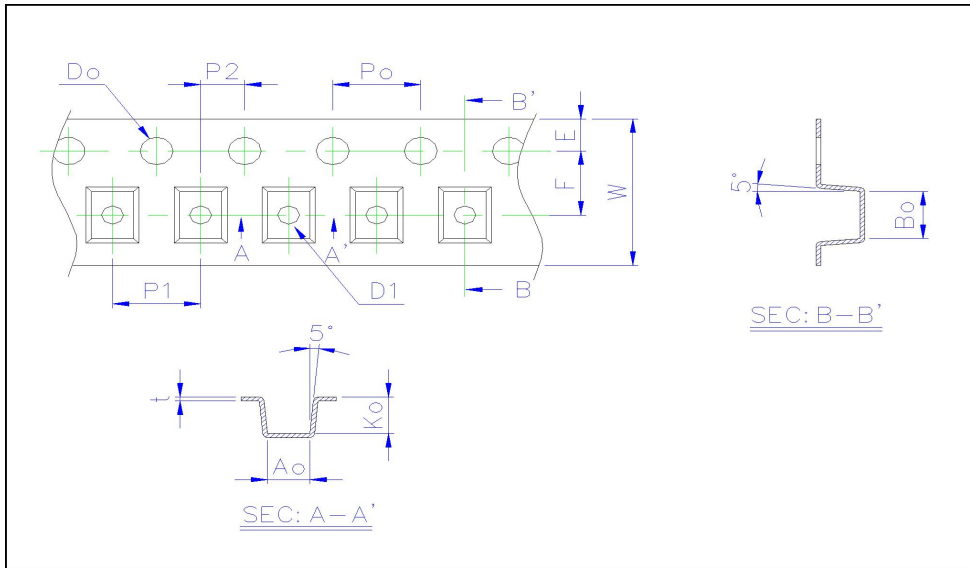

Size	Ao(mm)	Bo(mm)	Ko(mm)	W(mm)	E(mm)	F(mm)	Po(mm)	P1(mm)	Do(mm)
4532	3.45±0.10	4.90±0.10	3.05±0.10	12.0±0.20	1.75±0.10	5.50±0.05	4.0±0.05	8.0±0.10	1.5±0.1